

# Индуктивные датчики самодиагностики LR12X-Z

## Технические характеристики

По вопросам продаж и поддержки обращайтесь:

Алматы (727)345-47-04  
Ангарск (3955)60-70-56  
Архангельск (8182)63-90-72  
Астрахань (8512)99-46-04  
Барнаул (3852)73-04-60  
Белгород (4722)40-23-64  
Благовещенск (4162)22-76-07  
Брянск (4832)59-03-52  
Владивосток (423)249-28-31  
Владикавказ (8672)28-90-48  
Владимир (4922)49-43-18  
Волгоград (844)278-03-48  
Вологда (8172)26-41-59  
Воронеж (473)204-51-73  
Екатеринбург (343)384-55-89

Иваново (4932)77-34-06  
Ижевск (3412)26-03-58  
Иркутск (395)279-98-46  
Казань (843)206-01-48  
Калининград (4012)72-03-81  
Калуга (4842)92-23-67  
Кемерово (3842)65-04-62  
Киров (8332)68-02-04  
Коломна (4966)23-41-49  
Кострома (4942)77-07-48  
Краснодар (861)203-40-90  
Красноярск (391)204-63-61  
Курск (4712)77-13-04  
Курган (3522)50-90-47  
Липецк (4742)52-20-81

Магнитогорск (3519)55-03-13  
Москва (495)268-04-70  
Мурманск (8152)59-64-93  
Набережные Челны (8552)20-53-41  
Нижний Новгород (831)429-08-12  
Новокузнецк (3843)20-46-81  
Ноябрьск (3496)41-32-12  
Новосибирск (383)227-86-73  
Омск (3812)21-46-40  
Орел (4862)44-53-42  
Оренбург (3532)37-68-04  
Пенза (8412)22-31-16  
Петрозаводск (8142)55-98-37  
Псков (8112)59-10-37  
Пермь (342)205-81-47

Ростов-на-Дону (863)308-18-15  
Рязань (4912)46-61-64  
Самара (846)206-03-16  
Санкт-Петербург (812)309-46-40  
Саратов (845)249-38-78  
Севастополь (8692)22-31-93  
Саранск (8342)22-96-24  
Симферополь (3652)67-13-56  
Смоленск (4812)29-41-54  
Сочи (862)225-72-31  
Ставрополь (8652)20-65-13  
Сургут (3462)77-98-35  
Сыктывкар (8212)25-95-17  
Тамбов (4752)50-40-97  
Тверь (4822)63-31-35

Тольятти (8482)63-91-07  
Томск (3822)98-41-53  
Тула (4872)33-79-87  
Тюмень (3452)66-21-18  
Ульяновск (8422)24-23-59  
Улан-Удэ (3012)59-97-51  
Уфа (347)229-48-12  
Хабаровск (4212)92-98-04  
Чебоксары (8352)28-53-07  
Челябинск (351)202-03-61  
Череповец (8202)49-02-64  
Чита (3022)38-34-83  
Якутск (4112)23-90-97  
Ярославль (4852)69-52-93

Россия +7(495)268-04-70

Казахстан +(727)345-47-04

Беларусь +(375)257-127-884

Узбекистан +998(71)205-18-59

Киргизия +996(312)96-26-47

эл.почта: [ahj@nt-rt.ru](mailto:ahj@nt-rt.ru) || сайт: <https://lanbao.nt-rt.ru/>

Self-diagnosis inductive sensors **LR12X** series



Features

- ◆ Non contact detection, safe and reliable;
- ◆ ASIC design;
- ◆ Additional monitoring function to the signal generated from sensor



Part number

PNP NO	LR12XCN37HPOZ	PNP NC	LR12XCN37HPCZ
--------	---------------	--------	---------------

Technical specifications

Mounting	Non-flush	Current consumption	≤25mA
Rated distance [Sn]	3.7mm	Circuit protection	Short-circuit, overload and reverse polarity
Assured distance [Sa]	0...2.96mm	Output indicator	...
Dimensions	M12*70mm	Ambient temperature	-25°C...70°C
Output	NO/NC (depends on part number)	Ambient humidity	35...95%RH
Supply voltage	20...30 VDC	Switching frequency [F]	300Hz
Standard target	Fe 12*12*1t	Voltage withstand	1000V/AC 50/60Hz 60S
Switch-point drifts[%/Sr]	≤ ± 10%	Insulation resistance	≥50MΩ (500VDC)
Hysteresis range [%/Sr]	1...20%	Vibration resistance	10...50Hz (1.5mm)
Repeat accuracy [R]	≤ 5%	Degree of protection	IP67
Load current	≤ 130mA	Housing material	Nickel-copper alloy
Residual voltage	≤ 5V	Connection type	2m PVC cable

Dimensions

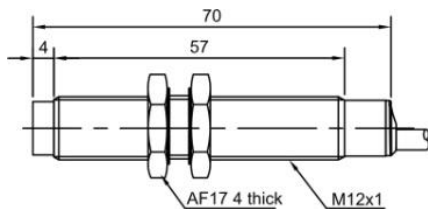

Wiring diagram

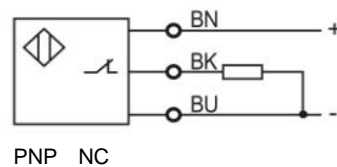
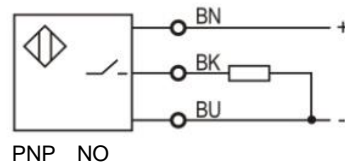

Self-diagnosis inductive sensors **LR12X** series



Features

- ◆ Non contact detection, safe and reliable;
- ◆ ASIC design;
- ◆ Additional monitoring function to the signal generated from sensor



Part number

PNP NO	LR12XDN37HPOZ-E2	PNP NC	LR12XDN37HPCZ-E2
--------	------------------	--------	------------------

Technical specifications

Mounting	Non-flush	Current consumption	≤25mA
Rated distance [Sn]	3.7mm	Circuit protection	Short-circuit, overload and reverse polarity
Assured distance [Sa]	0...2.96mm	Output indicator	...
Dimensions	M12*89mm	Ambient temperature	-25°C...70°C
Output	NO/NC (depends on part number)	Ambient humidity	35...95%RH
Supply voltage	20...30 VDC	Switching frequency [F]	300Hz
Standard target	Fe 12*12*1t	Voltage withstand	1000V/AC 50/60Hz 60S
Switch-point drifts[%/Sr]	≤ ± 10%	Insulation resistance	≥50MΩ (500VDC)
Hysteresis range [%/Sr]	1...20%	Vibration resistance	10...50Hz (1.5mm)
Repeat accuracy [R]	≤ 5%	Degree of protection	IP67
Load current	≤ 130mA	Housing material	Nickel-copper alloy
Residual voltage	≤ 5V	Connection type	M12 connector

Dimensions

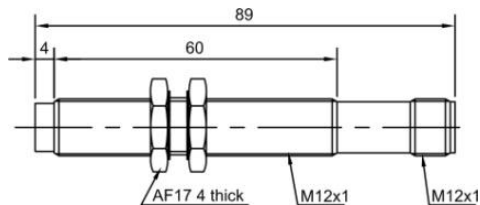

Wiring diagram

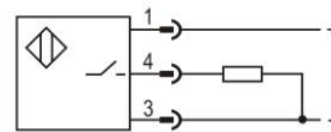

PNP NO

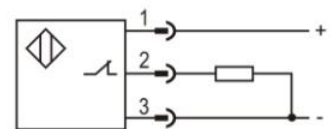

PNP NC



Self-diagnosis inductive sensors **LR12X** series



Features

- ◆ Non contact detection, safe and reliable;
- ◆ ASIC design;
- ◆ Additional monitoring function to the signal generated from sensor



Part number

PNP NO	LR12XBN37HPOZ-E2	PNP NC	LR12XBN37HPCZ-E2
--------	------------------	--------	------------------

Technical specifications

Mounting	Non-flush	Current consumption	≤25mA
Rated distance [Sn]	3.7mm	Circuit protection	Short-circuit, overload and reverse polarity
Assured distance [Sa]	0...2.96mm	Output indicator	...
Dimensions	M12*69mm	Ambient temperature	-25°C...70°C
Output	NO/NC (depends on part number)	Ambient humidity	35...95%RH
Supply voltage	20...30 VDC	Switching frequency [F]	300Hz
Standard target	Fe 12*12*1t	Voltage withstand	1000V/AC 50/60Hz 60S
Switch-point drifts[%/Sr]	≤ ± 10%	Insulation resistance	≥50MΩ (500VDC)
Hysteresis range [%/Sr]	1...20%	Vibration resistance	10...50Hz (1.5mm)
Repeat accuracy [R]	≤ 5%	Degree of protection	IP67
Load current	≤ 130mA	Housing material	Nickel-copper alloy
Residual voltage	≤ 5V	Connection type	M12 connector

Dimensions

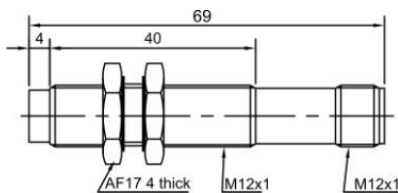

Wiring diagram

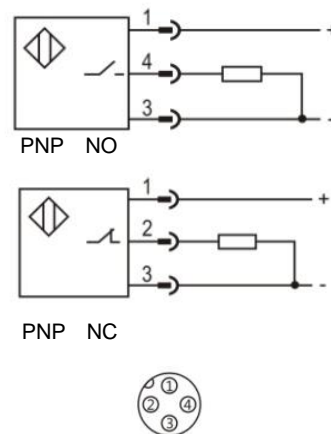

## По вопросам продаж и поддержки обращайтесь:

Алматы (727)345-47-04  
Ангарск (3955)60-70-56  
Архангельск (8182)63-90-72  
Астрахань (8512)99-46-04  
Барнаул (3852)73-04-60  
Белгород (4722)40-23-64  
Благовещенск (4162)22-76-07  
Брянск (4832)59-03-52  
Владивосток (423)249-28-31  
Владикавказ (8672)28-90-48  
Владимир (4922)49-43-18  
Волгоград (844)278-03-48  
Вологда (8172)26-41-59  
Воронеж (473)204-51-73  
Екатеринбург (343)384-55-89

Иваново (4932)77-34-06  
Ижевск (3412)26-03-58  
Иркутск (395)279-98-46  
Казань (843)206-01-48  
Калининград (4012)72-03-81  
Калуга (4842)92-23-67  
Кемерово (3842)65-04-62  
Киров (8332)68-02-04  
Коломна (4966)23-41-49  
Кострома (4942)77-07-48  
Краснодар (861)203-40-90  
Красноярск (391)204-63-61  
Курск (4712)77-13-04  
Курган (3522)50-90-47  
Липецк (4742)52-20-81

Магнитогорск (3519)55-03-13  
Москва (495)268-04-70  
Мурманск (8152)59-64-93  
Набережные Челны (8552)20-53-41  
Новокузнецк (3843)20-46-81  
Ноябрьск (3496)41-32-12  
Новосибирск (383)227-86-73  
Омск (3812)21-46-40  
Орел (4862)44-53-42  
Оренбург (3532)37-68-04  
Пенза (8412)22-31-16  
Петрозаводск (8142)55-98-37  
Псков (8112)59-10-37  
Пермь (342)205-81-47

Ростов-на-Дону (863)308-18-15  
Рязань (4912)46-61-64  
Самара (846)206-03-16  
Санкт-Петербург (812)309-46-40  
Саратов (845)249-38-78  
Севастополь (8692)22-31-93  
Саранск (8342)22-96-24  
Симферополь (3652)67-13-56  
Смоленск (4812)29-41-54  
Сочи (862)225-72-31  
Ставрополь (8652)20-65-13  
Сургут (3462)77-98-35  
Сыктывкар (8212)25-95-17  
Тамбов (4752)50-40-97  
Тверь (4822)63-31-35

Тольятти (8482)63-91-07  
Томск (3822)98-41-53  
Тула (4872)33-79-87  
Тюмень (3452)66-21-18  
Ульяновск (8422)24-23-59  
Улан-Удэ (3012)59-97-51  
Уфа (347)229-48-12  
Хабаровск (4212)92-98-04  
Чебоксары (8352)28-53-07  
Челябинск (351)202-03-61  
Череповец (8202)49-02-64  
Чита (3022)38-34-83  
Якутск (4112)23-90-97  
Ярославль (4852)69-52-93

**Россия** +7(495)268-04-70

**Казахстан** +(727)345-47-04

**Беларусь** +(375)257-127-884

**Узбекистан** +998(71)205-18-59

**Киргизия** +996(312)96-26-47

эл.почта: [ahj@nt-rt.ru](mailto:ahj@nt-rt.ru) || сайт: <https://lanbao.nt-rt.ru/>